



Profit from the Eagle Advantage®

Specification Sheet

Short Form Specifications

Eagle Spec-Bar® Hand Sink, model _____.
Heavy gauge type 304 stainless steel sink, body, legs, leg channels and cross rails. 1½" stainless steel I.P.S. threaded drain with nut and washer. Stainless steel adjustable bullet feet.

HS models: Furnished with deck mounted T&S faucet.

HSD models: Furnished with front door with paper towel dispenser, deck mounted soap dispenser, and splash mounted T&S faucet.



Options / Accessories

- Removable stainless steel perforated strainer

Item No.: _____
Project No.: _____
S.I.S. No.: _____

Spec-Bar® Hand Sinks

MODELS:

- HS12-19**
- HS12-24**
- HS18-19**
- HS18-24**
- HSD12-24**
- HSD18-19**
- HSD18-24**

Design and Construction Features

- Body, legs and crossbracing constructed of type 304 stainless steel for strength and corrosion resistance.
- Backsplash, sides, bottom, front panel or door, and bowl are 20 gauge stainless steel.
- Leg channels, legs and crossbracing are 16 gauge stainless steel.
- Legs are 1½" (41mm) diameter type 304 stainless steel with stainless steel adjustable bullet feet.
- Sink bowl is 9¼" x 11½" x 6" (235 x 292 x 152mm) deep with hot and cold water gooseneck faucet.
- Faucets are deck mounted on 4" (102mm) centers with ½" (13mm) NPT inlet and hot and cold water connections required.
- Deluxe "HSD" models feature front access hinged door, soap dispenser and paper towel dispenser.
- 1½"(38mm) I.P.S. threaded drain with nut and washer.

EAGLE GROUP

100 Industrial Boulevard, Clayton, DE 19938-8903 USA
Phone: 302-653-3000 • 800-441-8440 • Fax: 302-653-2065
www.eaglegrp.com
www.eaglemhc.com

For custom configuration or fabrication needs, contact our **SpecFAB® Division**.
Phone: 302-653-3000 • Fax: 302-653-2065 • e-mail: quotes@eaglegrp.com



EG40.34 Rev. 05/24

Spec sheets available for viewing, printing or downloading from our online literature library at our websites

Eagle Foodservice Equipment, Eagle MHC, and SpecFAB® are divisions of Eagle Group. ©2024 by the Eagle Group



Profit from the Eagle Advantage®

Item No.: _____
 Project No.: _____
 S.I.S. No.: _____

Spec-Bar® Hand Sinks

19" (483mm)-wide Units

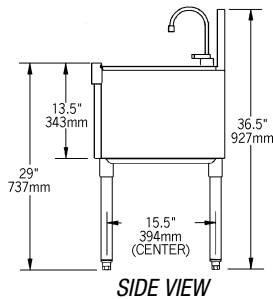
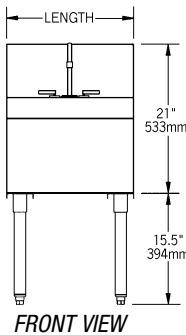
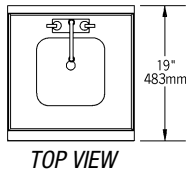

model #	width		length		weight	
	in.	mm	in.	mm	lbs.	kg
HS12-19	19"	483	12"	305	30	13.6
HS18-19	19"	483	18"	457	35	15.9

24" (610mm)-wide Units

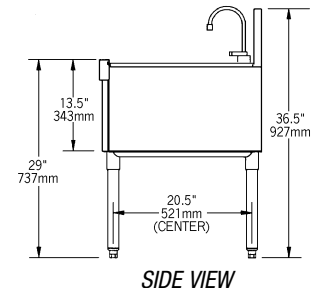
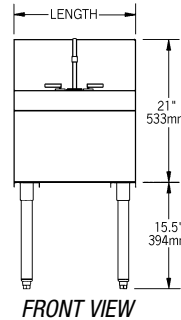
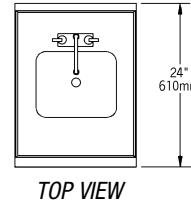

model #	width		length		weight	
	in.	mm	in.	mm	lbs.	kg
HS12-24	24"	610	12"	305	35	15.9
HS18-24	24"	610	18"	457	40	18.1

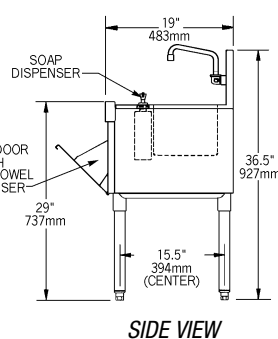
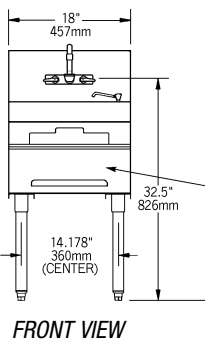
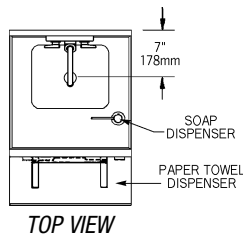

model #	width		length		weight	
	in.	mm	in.	mm	lbs.	kg
HSD18-19	19"	483	18"	457	45	20.4

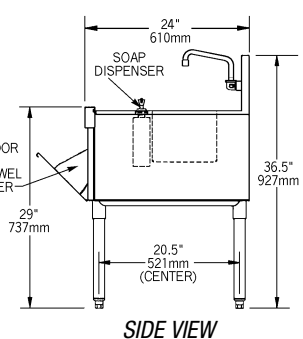
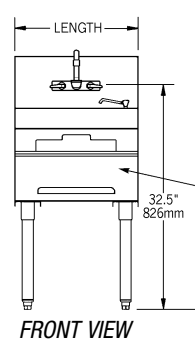
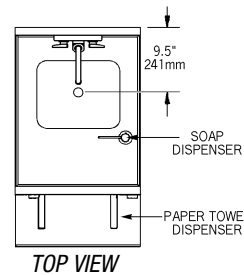

model #	width		length		weight	
	in.	mm	in.	mm	lbs.	kg
HSD12-24	24"	610	12"	305	45	20.4
HSD18-24	24"	610	18"	457	50	22.7

EAGLE GROUP

100 Industrial Boulevard, Clayton, DE 19938-8903 USA
 Phone: 302-653-3000 or 800-441-8440 • Fax: 302-653-2065
 www.eaglegrp.com • www.eaglehmc.com

Printed in U.S.A.
 ©2024 by Eagle Group

Rev. 05/24

Spec sheets available for viewing, printing or downloading from our online literature library at our websites

Although every attempt has been made to ensure the accuracy of the information provided, we cannot be held responsible for typographical or printing errors. Information and specifications are subject to change without notice. Please confirm at time of order.