

Shoe Racks

ASSEMBLY INSTRUCTIONS

CAUTION

INSPECT CONTENTS IMMEDIATELY AND FILE CLAIM WITH DELIVERING CARRIER FOR ANY DAMAGE.
SAVE YOUR BOX AND ALL PACKING MATERIALS.
 YOU ARE RESPONSIBLE FOR DAMAGE TO YOUR UNIT IF RETURNED IMPROPERLY PACKED.

BEFORE ASSEMBLY, PLEASE READ:

Attach foot plate to each post by screwing into bottom of post as shown.

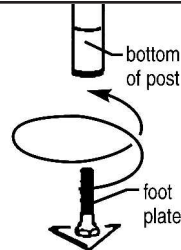

Step 1 - Attach split sleeves (for bottom shelf) onto #6 groove on posts.

- The wider part of the taper goes toward the bottom.
- Make sure rib on split sleeve is seated into a groove on the post.

Note: The number covered by the split sleeve indicates approximate height of shelf.

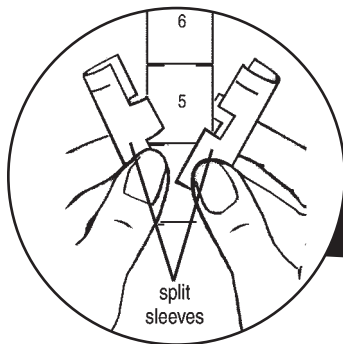

Step 2 - Mount bottom shelf.

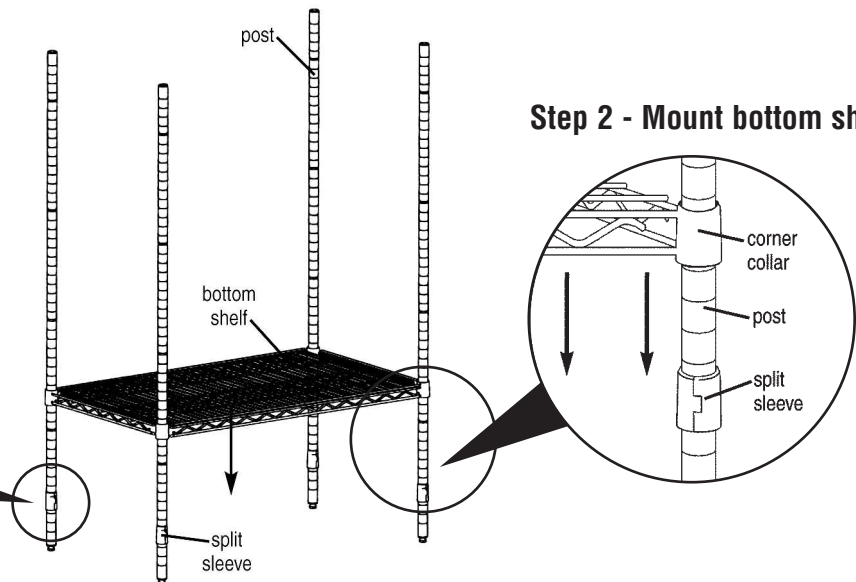

(continued on page 2)

EG10076 Revised 09/08



Profit from the Eagle Advantage®

- 100 Industrial Boulevard, Clayton, Delaware 19938-8903 U.S.A. • www.eaglegrp.com
- Phone: 302/653-3000 • (Foodservice) 800/441-8440 • (MHC/Retail) 800/637-5100
- Fax: 302/653-2065

Eagle Foodservice Equipment, Eagle MHC, SpecFAB®, and Retail Display are divisions of Eagle Group. ©2008 by the Eagle Group

Shoe Racks

ASSEMBLY INSTRUCTIONS

Step 3: Mount additional split sleeves and shelves, referring to illustration below.

- Repeat Steps 1 & 2 (front page), mounting one set of 4 split sleeves at a time, followed by adjoining shelf, onto the post groove location specified.
- Start with the bottommost location, and work from bottom to top.

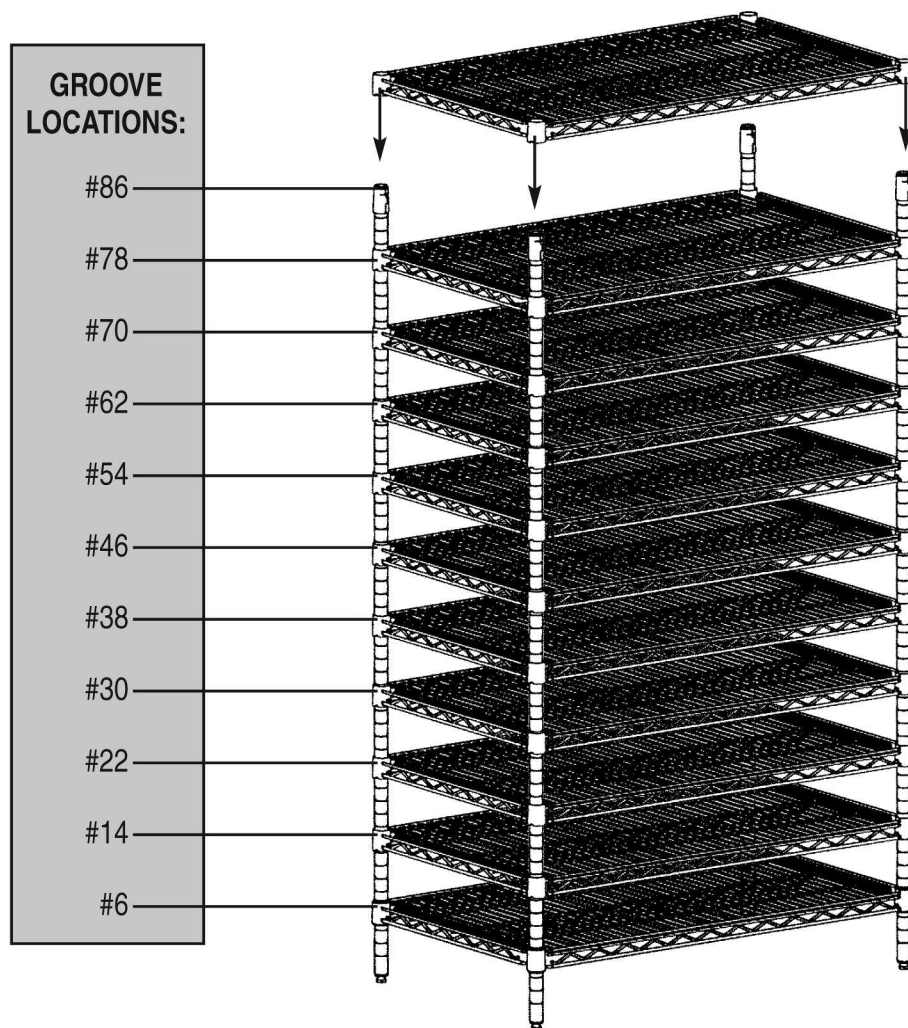

(continued on page 3)

Shoe Racks

ASSEMBLY INSTRUCTIONS

Before continuing, please note:

- Please read ahead BEFORE assembly.
- These instructions cite installation of one rod at a time.
- These instructions cite installation of rods & tabs onto outside of wire shelves. Rods & tabs will be installed along middle area of wire shelves as well.
- Hooked end of rods can be mounted from bottom shelf to extend rods through top shelf for additional storage dividers (see back page). These instructions show hooked end of rods mounted at top shelf.

Step 4 - Attach rod to desired location.

NOTE: For ease of assembly, lay shelving unit on its side before installing rods.

- Hook rod onto outside of top wire shelf.
- Make sure rod is parallel with posts of shelf unit.

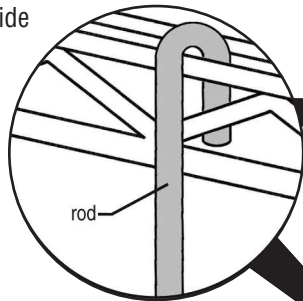

Step 5 - Attach tab to rod and shelf.

- Slide tab notch onto rod.
- Push tab up and onto bottom of shelf truss.

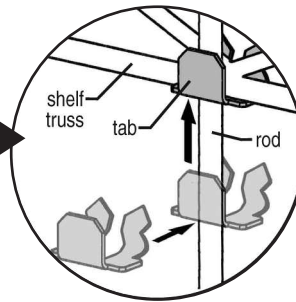

Step 6 - Attach remaining tabs onto rod.

Repeat Step 2, attaching tabs where rod intersects with adjacent wire shelves remaining.

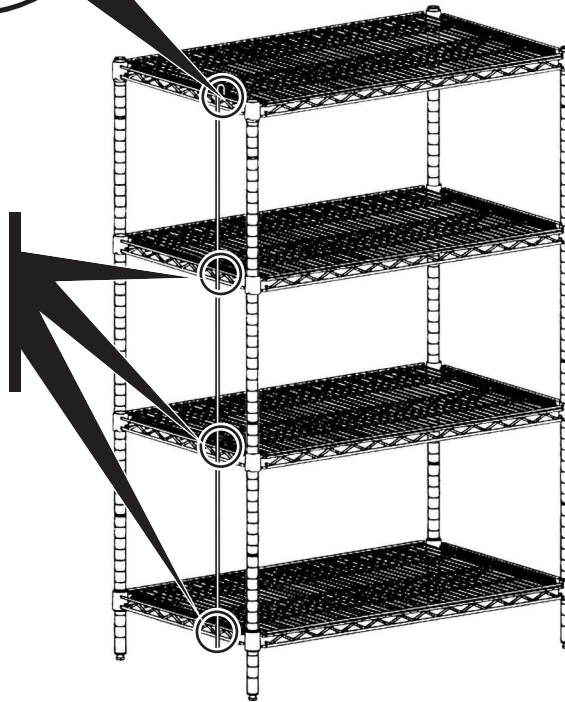

To install remaining rods & tabs, repeat Steps 4 through 6. Distribute evenly along shelf to create "cubbies," referring to appropriate diagram below for approximate placement of rods.

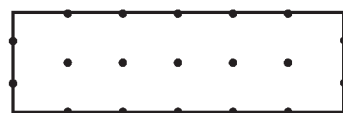

overhead view of 60"-long unit
(makes 60 cubbies)

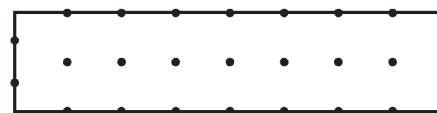

overhead view of 72"-long unit
(makes 80 cubbies)

When all rods & tabs are installed, assembly of shoe rack is complete.

(End)

Shoe Racks

ASSEMBLY INSTRUCTIONS

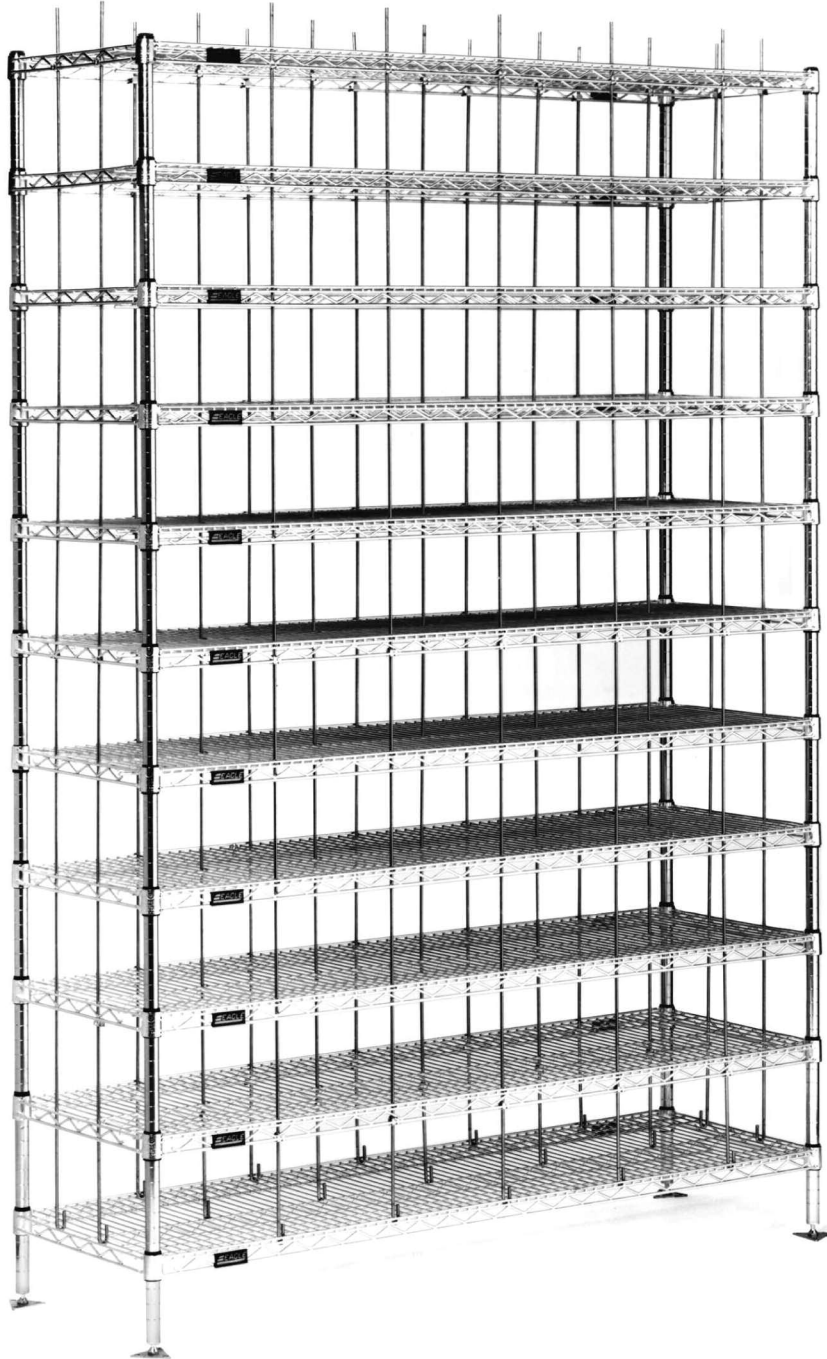

shoe rack shown with hooked end of robs mounted from bottom shelf



Profit from the Eagle Advantage®

- 100 Industrial Boulevard, Clayton, Delaware 19938-8903 U.S.A. • www.eaglegrp.com
- Phone: 302/653-3000 • (Foodservice) 800/441-8440 • (MHC/Retail) 800/637-5100
- Fax: 302/653-2065

Eagle Foodservice Equipment, Eagle MHC, SpecFAB®, and Retail Display are divisions of Eagle Group. ©2008 by the Eagle Group